

# SPECIFICATIONS FOR APPROVAL

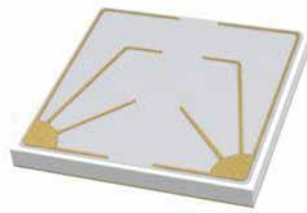

## Vertical UV-A Chip

MODEL NAME : LEUV-V518A6

**RoHS**  
Compliant

**Halogen**  
Compliant

**IRTRONIX**  
Global Partner in UV LED Solutions

Tel. 310.787.1100 Ext. 7003 Fax. 310.787.1166  
Global Headquarters  
20900 Normandie Avenue Bldg. B, Torrance, CA 90502  
[www.irtronix.com](http://www.irtronix.com)

 **LG Innotek**

## TABLE OF CONTENTS

1. Features	-----	3
2. Applications	-----	3
3. Mechanical Dimensions	-----	3
4. Absolute Maximum Ratings	-----	4
5. Electrical / Optical Characteristics	-----	4
6. Mechanical Specifications	-----	4
7. Standard Binning Table	-----	5
8. Typical Characteristic Curves	-----	6
9. Packing and Labeling	-----	8
10. Cautions on Use	-----	10

## 1. Features

- AlGaIn/InGaIn-based thin-film vertical LED chip technology
- High brightness and efficiency
- Excellent thermal management capability with metal alloy support
- Compatible with silver epoxy, solder paste, solder preform, or eutectic attach
- Long operation lifetime
- Lambertian radiation

## 2. Applications

- UV curing system
- UV inspection system
- Industrial machine vision system
- Photolithography system

## 3. Mechanical Dimensions

- Chip size :  $1100 \times 1100 \pm 50\mu\text{m}$
- P-N Junction size :  $1050 \times 1050 \pm 50\mu\text{m}$
- Total thickness :  $130 \pm 20\mu\text{m}$
- Bond pad :  $160 \pm 20\mu\text{m}$
- Backside metallization with Gold

Unit :  $\mu\text{m}$

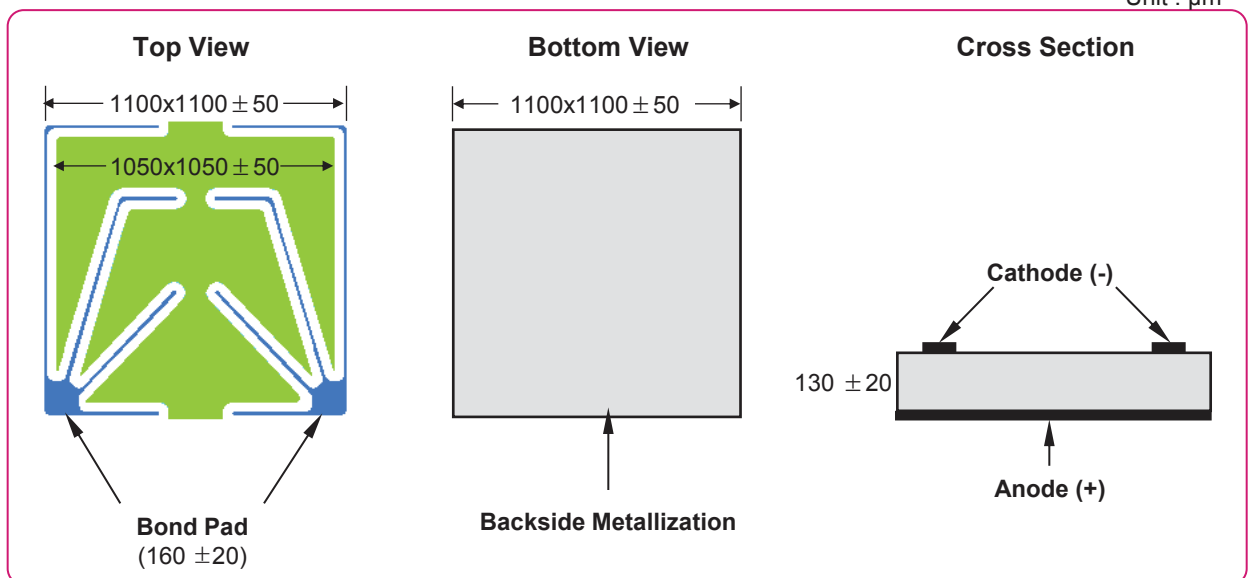

## 4. Absolute Maximum Ratings (Ta = 25 °C) <sup>Note 1</sup>

Items	Symbols	Rating	Unit
DC Forward Current <sup>Note 2</sup>	If	1000	mA
Peak Forward Current <sup>Note 3</sup>	I <sub>fp</sub>	1000	mA
LED Junction Temperature	T <sub>j</sub>	130	°C
Reverse Voltage	V <sub>r</sub>	5	V
Operating Temperature		-10 ~ 100	°C
Storage Temperature (Bare Chip)		-40 ~ 100	°C
Assembly Processing Temperature		325 (< 5sec)	°C

## 5. Electrical / Optical Characteristics (Ta = 25 °C)

Items	Symbol	Condition	Min.	Typ.	Max.	Unit
Forward Voltage	V <sub>f</sub>	500mA	3.4		4.0	V
Turn-On Voltage	V <sub>on</sub>	0.5mA	2.3		3.1	V
Peak Wavelength <sup>Note 4</sup>	W <sub>p</sub>	500mA	360		369.5	nm
Radiant Flux <sup>Note 5</sup>	P <sub>o</sub>	500mA	520		760	mW

## 6. Mechanical Specifications

Items	Dimension	Tolerance	Unit
Chip Area	1100 x 1100	±50	μm
P-N Junction Area	1050 x 1050	±50	
Chip Thickness	130	±20	
Bond Pad	160	±20	
Bond Pad Thickness	2.8	±0.28	
Backside Metal Area	1100 x 1100	±50	
Backside Metal Thickness	5.0	±0.5	

### Notes:

- Maximum ratings are strongly package-dependent. The above ratings were determined using a LGIT SMT package and Ag epoxy die attach for characterization. Ratings for other packages may differ.
- Under the maximum junction temperature
- 1/10 duty cycle @ 1 kHz
- Wavelength tolerance is within ± 1nm.
- Radiant flux is based on LGIT internal standard of the optical measurement and may differ from that measured by the others. Typical tolerance of the radiant flux is ± 5%.

## 7. Standard Binning Table (If = 500mA, Ta = 25 °C) <sup>Note 1</sup>

Cx (@500mA)	Forward Voltage (V)	Radiant Flux (mW)					
		520~560	560~600	600~640	640~680	680~720	720~760
0 ~ 0.235	3.4 ~ 3.5	X01	X02	X03	X04	X05	X06
	3.5 ~ 3.6	X07	X08	X09	X10	X11	X12
	3.6 ~ 3.7	X13	X14	X15	X16	X17	X18
	3.7 ~ 3.8	X19	X20	X21	X22	X23	X24
	3.8 ~ 4.0	-	-	-	-	X25	X26
0.235 ~ 0.3 0.3	3.4 ~ 3.5	X27	X28	X29	X30	X31	X32
	3.5 ~ 3.6	X33	X34	X35	X36	X37	X38
	3.6 ~ 3.7	X39	X40	X41	X42	X43	X44
	3.7 ~ 3.8	X45	X46	X47	X48	X49	X50
	3.8 ~ 4.0	-	-	-	-	X51	X52

※ Peak Wavelength: 360~369.5nm

**Notes:**

- LEDs from above ranks will be shipped.  
The rank combination ratio per shipment will be decided by LG innotek.

## 8. Typical Characteristic Curves (Ta = 25 °C)

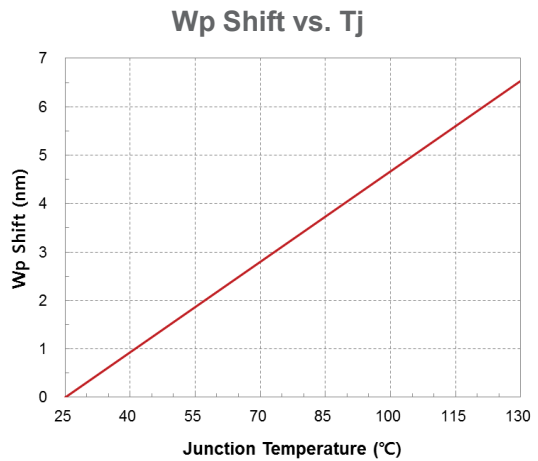
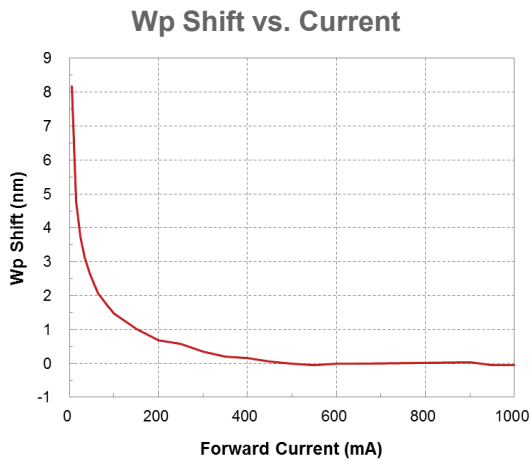
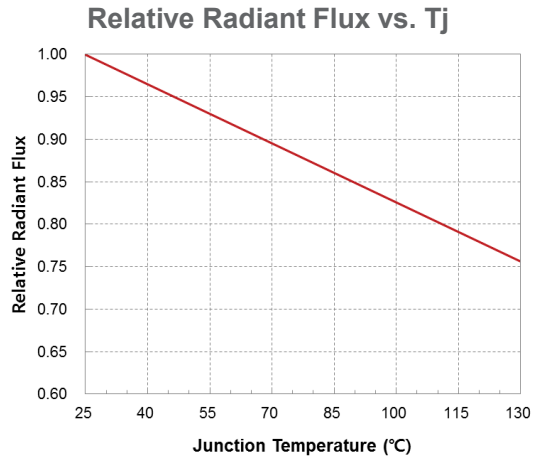
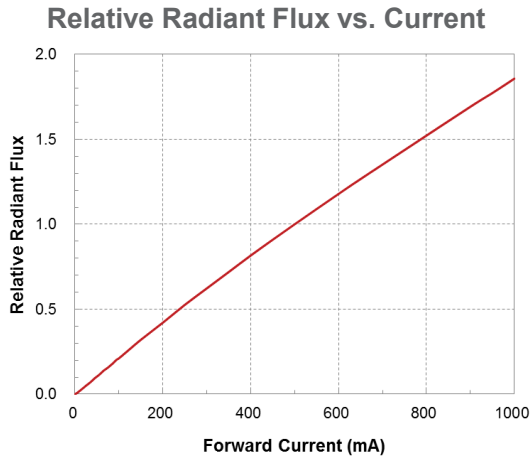
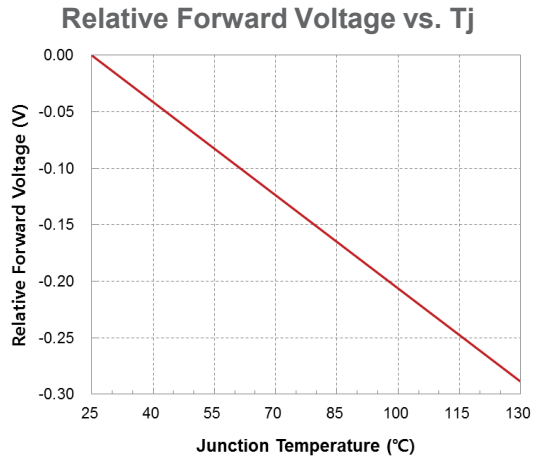
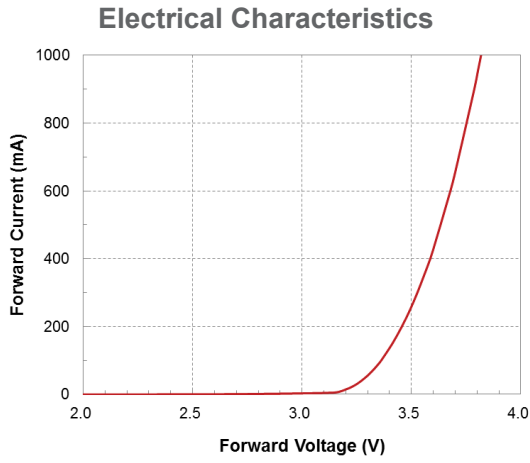

### Radiation Pattern

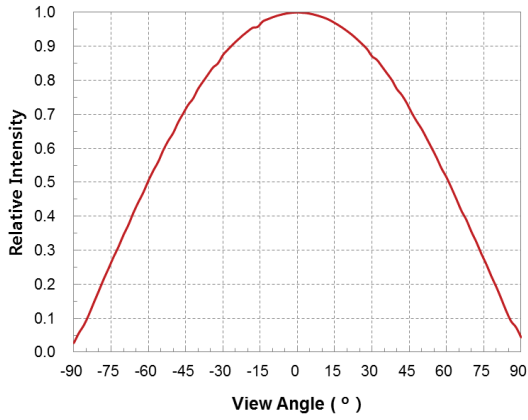

Typical Viewing Angle = 120°  
(Lambertian Emission)

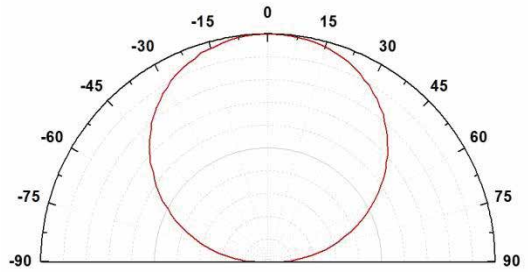

### Spectral Power Distribution

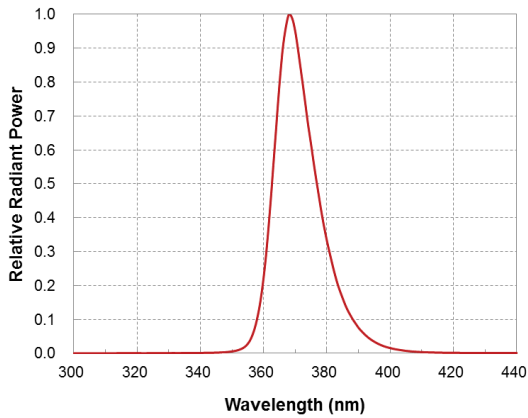

### Derating Curves Note 1

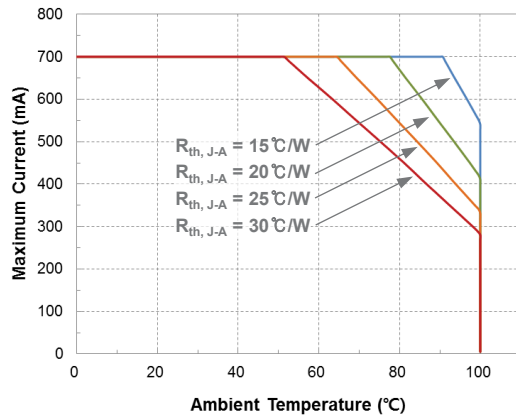

#### Notes:

1. The maximum forward current is determined by the thermal resistance (R<sub>J-A</sub>) between the LED junction and ambient.

## 9. Packing and Labeling

### Packing

LED chips are mounted on the adhesive tapes and contamination-free cover sheet with a square array. Those sheets are contained into an anti-electrostatic moisture-proof bag with desiccants (silica gel) and the bag is sealed off. Four bags are packed into a inner box and six inner boxes are again packed into a large outer box.

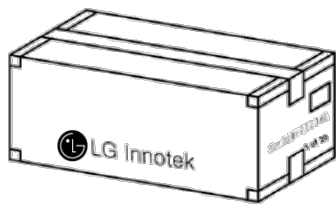
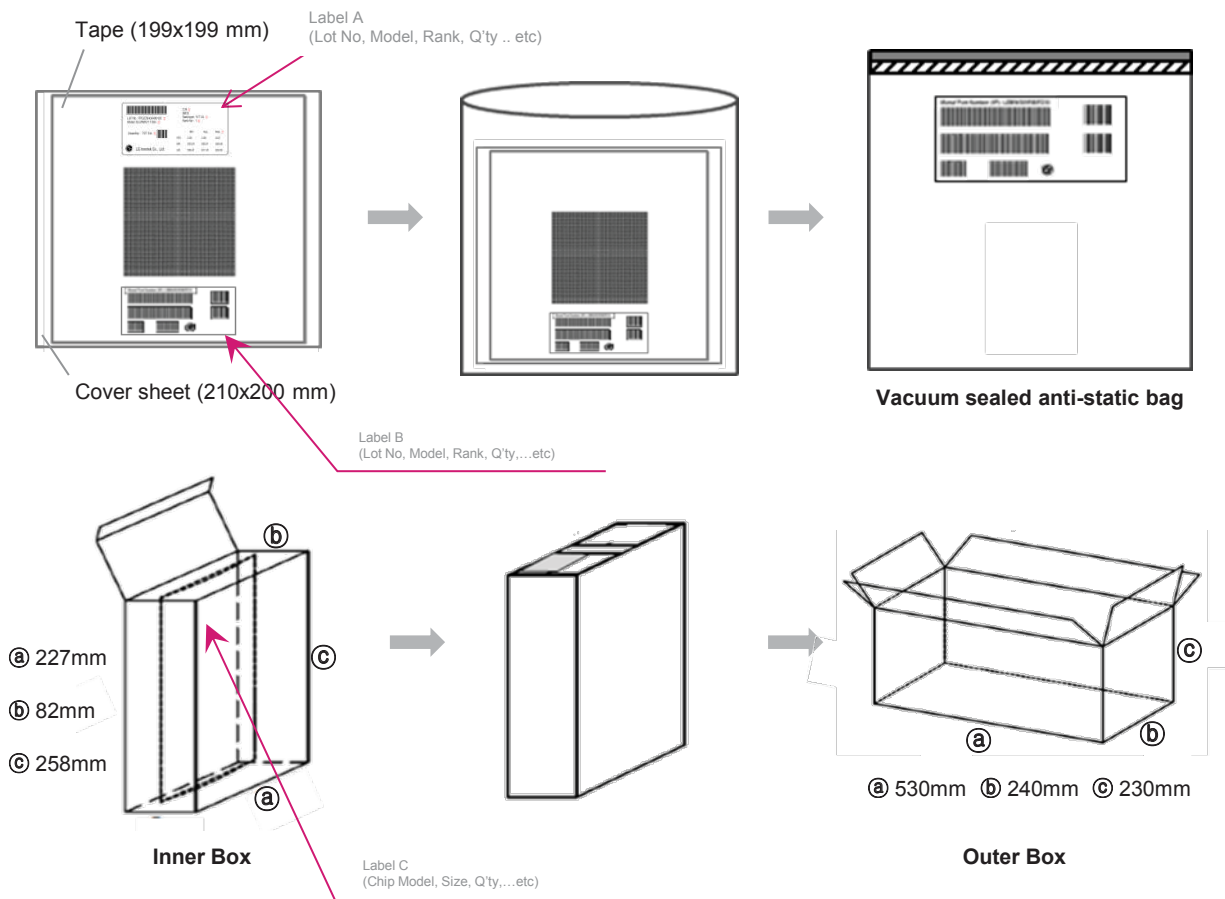

Outer Box

#### ※ Typical arrangement of LED chips on the tape

Q'ty per sheet (pcs)	Array (Colum x Row)	Die Pitch (μm)
1800	60x30	400



## Labeling

### ※ Label A

Specifying 'Lot Number ①', 'Model Number ②', 'Quantity ③'  
'MRM Code (optional) ④', 'Rank type ⑤', 'Rank Ver ⑥' and 'Summary of Bin Characteristic ⑦'.

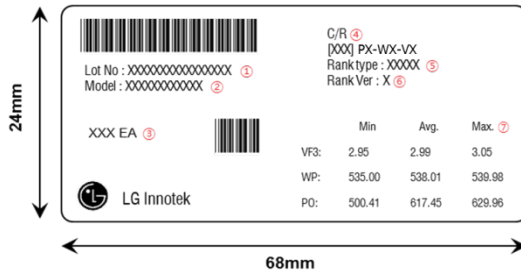

### ※ Label B

Specifying 'Lot Number ①', 'Quantity ②', 'Model Number ③', 'Chip size ④'  
'Growth Number ⑤', 'Manufacturing Machine Number ⑥', 'Date ⑦',  
'Summary of Bin Characteristic ⑧', 'Rank type and Ver. ⑨' and 'MRM Code (optional) ⑩'.

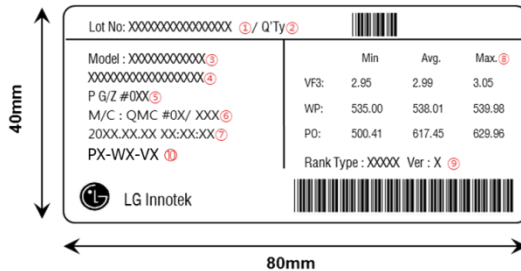

### ※ Label C

Specifying 'Chip Model ①', 'Chip Size ②', 'IN Box ID ③' and 'Total Q'ty ④'.

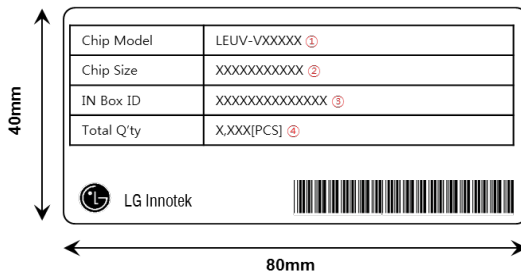

## Box ID Indication



System	Area	Year	Month	Date	Seq
Shipping : S	MES : M	Paju : P	2015	(01 ~ 12)	(01 ~ 31)
Return : R	STK : S	Huizhou : H	2020		(001 ~ 999)

## 10. Cautions on Use

### Storage Environment

- The storage location should be kept at normal temperature and humidity, that is 25 to 35°C and 45 to 70% relative humidity. Care must be taken to avoid storage under temperature and humidity conditions that are significantly different from these.
- Avoid storage in a location with corrosive gas or a large amount of dust.
- Sudden temperature variations can cause condensation to form on devices and/or packing material, so avoid such an environment.
- Store devices in a location with free of radiation, static electricity and strong electromagnetic fields.

### Electrostatic Discharge (ESD) Damage

- Caution is necessary in handling LED chips since they are generally susceptible to destruction due to electrostatic discharge.
- All equipment and human bodies must be properly grounded.
- Use wrist strap or anti-electrostatic gloves when manually handling the chips.
- It is recommended to use an ionizer (an air-ionizing blower) in handling the chips or the manufacturing processes.

### Handling Precautions

- Minimize contact between metallic fixtures, tweezers, or other hard objects and the emitting surface. Applying excessive contact force can damage the junction and lead to increased leakage current as a consequence.
- If possible, avoid the use of tapes or adhesives to the emitting surface which is subject to be contaminated by tape residue. Contaminated surface leads to reduced light extraction.
- Rubber collets are strongly recommended during the die pick and place process. Harder plastic collets may also be used with minimized die bonding parameters (bonding pressure).
- Recommended minimum tip radius of ejector pins contacting the bottom surface of the chip during the die pick process is 75µm in order to prevent chip damage.
- Gold ball bonding is recommended as an electrical connection. Wire bonding parameters (pressure and ultrasonic power) should be chosen to prevent excess stress from damaging the bond pad and chip.

- When UV-Chip is in contact with an electric current, UV Light is emitted, which may cause severe damage to the bare skin or eyes. When handling the product, one must use protective wear to protect bare skin. Protective UV-goggles must be worn to prevent harm to the eyes.

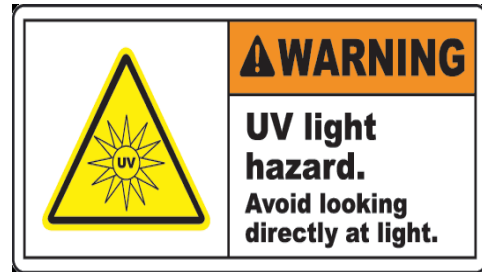

## Others

- LG Innotek will not be held responsible for any damage to the user that may result from accidents or any other reasons during operation of the user's unit if use to exceed the absolute maximum ratings. Or not keep the matters that demand special attention.
- The customer shall not reverse engineer by disassembling or analysis of the LEDs without having prior written consent from LG Innotek. When defective LEDs are found, the customer shall inform LG Innotek disassembling or analysis.
- The appearance and specification of the product may be modified for improvement without notice.