

SPECIFICATIONS FOR APPROVAL

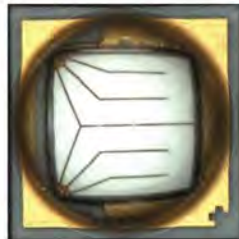

405nm UV LED PKG

MODEL NAME : LEUVA33W70VL00

RoHS
Compliant

IRTRONIX
Global Partner in UV LED Solutions

Tel. 310.787.1100 Ext. 7003 Fax. 310.787.1166
Global Headquarters
20900 Normandie Avenue Bldg. B, Torrance, CA 90502
www.irtronix.com

 **LG Innotek**

TABLE OF CONTENTS

1. Features	-----	2
2. Outline Dimensions	-----	2
3. Applications	-----	3
4. Absolute Maximum Ratings	-----	3
5. Electro-Optical Characteristics	-----	3
6. Bin Structures	-----	4
7. Typical Characteristic Curves	-----	5~6
8. Reliability Test Items and Conditions	-----	7
9. Packing and Labeling of Products	-----	8~11
10. Cautions on Use	-----	12~16
11. Disclaimers	-----	16

1. Features

- Surface Mount Type : 3.40×3.40×2.37 (L×W×H, Unit : mm)
- Viewing Angle(Directivity) : Typical 130°
- Soldering Methods : Pb-Free IR-Reflow Soldering

2. Outline Dimensions

(Unit : mm)

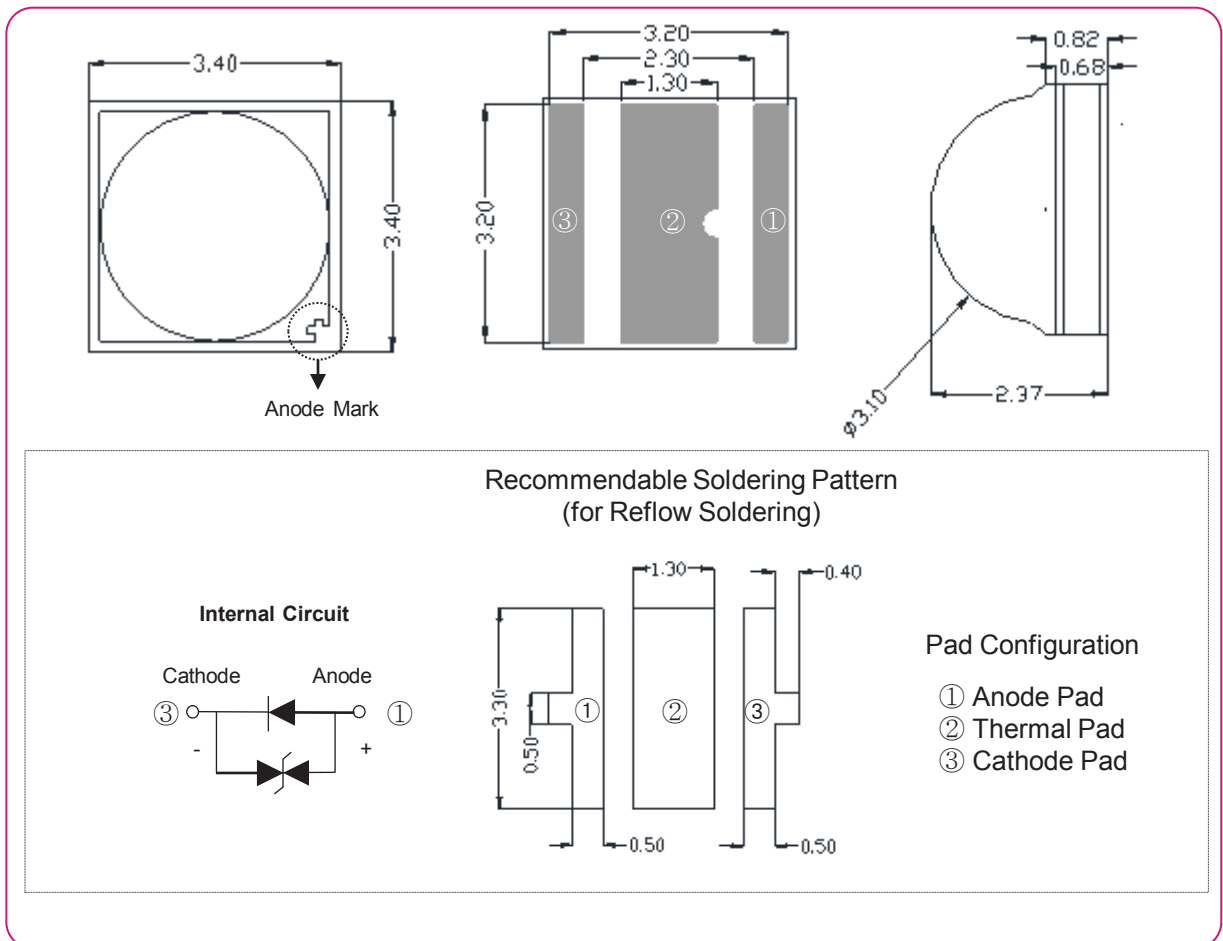

Tolerances unless otherwise mentioned are ± 0.13 mm

3. Applications

- UV Curing, UV Ink Curing, Photo-Catalyst, Sensor Light, etc.

4. Absolute Maximum Ratings

(Ta= 25°C)

Items	Symbols	Ratings	Unit
Forward Current	If	1.5	A
Power Dissipation	Pd	6.0	W
Operating Temperature	Topr	-10 ~ +85	°C
Storage Temperature	Tstg	-40 ~ +100	°C
Junction Temperature	Tj	<100	°C
Soldering Temperature	JEDEC-J-STD-020D		
ESD Classification	Class 2 (JESD22-A114)		

- ※ Operating the LED beyond the listed maximum ratings may affect device reliability and cause permanent damage. These or any other conditions beyond those indicated under recommended operating conditions are not implied. The exposure to the absolute maximum rated conditions may affect device reliability.
- ※ The LEDs are not designed to be driven in reverse bias

5. Electro-Optical Characteristics

(Ta= 25°C)

Items	Symbol	Condition	Target Spec.			Unit
			Min.	Typ.	Max.	
Forward Voltage	Vf		3.2	-	4.0	V
Radiant Flux	Φe		1600	1900	2340	mW
Peak Wavelength	λp	If = 1.0A	400	405	410	nm
Spectrum Half Width	Δλ		-	12	-	nm
Viewing Angle	2Θ1/2		-	130	-	deg
Thermal Resistance ^{*1)}	Rth j-c		-	4.5	-	°C/W

*1) Rthj-c = Thermal Resistance (Junction – Case)

- ※ These values are measured by the LG Innotek optical spectrum analyzer within the following tolerances.
 - Forward Voltage(Vf) : ±0.1V
 - Peak Wavelength(λp) : ±3.0nm
 - Radiant Flux(Φe) : ±10%
- ※ Although all LEDs are tested by LG Innotek equipment, some values may vary slightly depending on the conditions of the test equipment.

6. Bin Structures

Items	Rank	Min	Max	Unit
Peak Wavelength	V1	400	405	nm
	V2	405	410	
Radiant Flux	IP3	2130	2340	mW
	IP2	1940	2130	
	IP1	1770	1940	
	IP0	1600	1770	
Forward Voltage	V3	3.6	3.8	V
	V2	3.4	3.6	
	V1	3.2	3.4	

※ Forward Current = 1.0A

※ Rank name method : Please refer to the following example

Rank Name : V1-IP2-V2

- Peak Wavelength = V1

- Radiant Flux = IP2

- Forward Voltage = V2

7. Typical Characteristic Curves

- Forward Current vs. Peak Wavelength

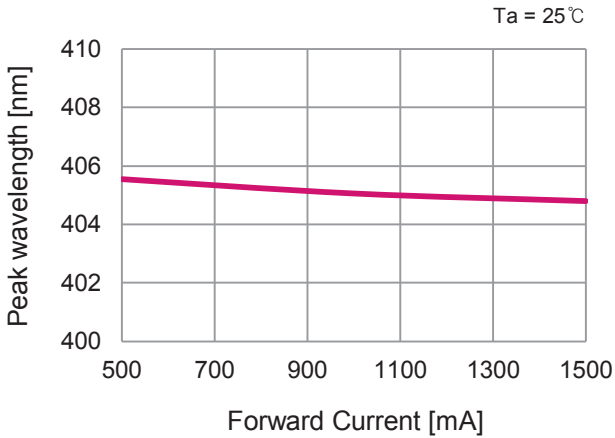

- Forward Current vs. Relative Radiant Flux

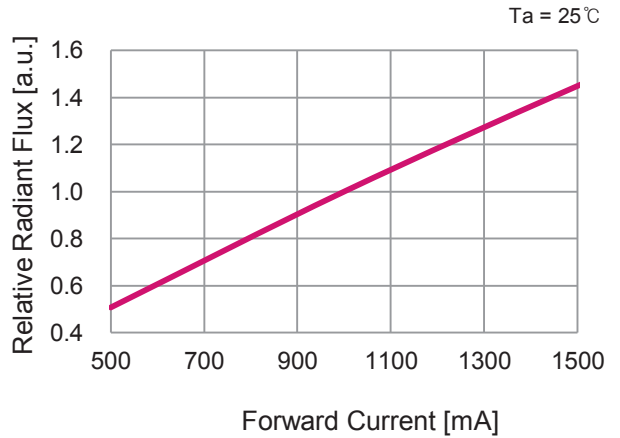

- Forward Current vs. Forward Voltage

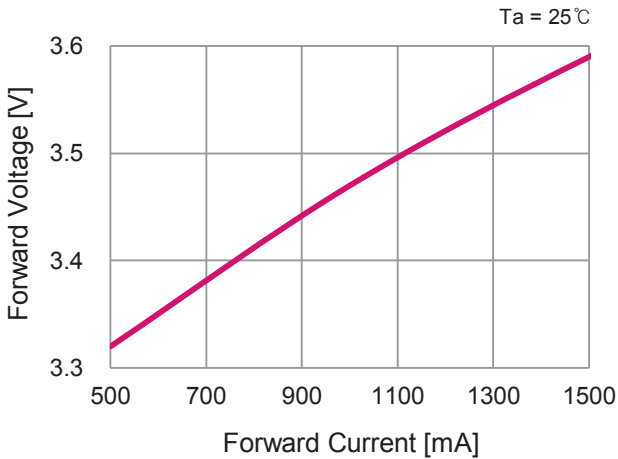

- Spectrum

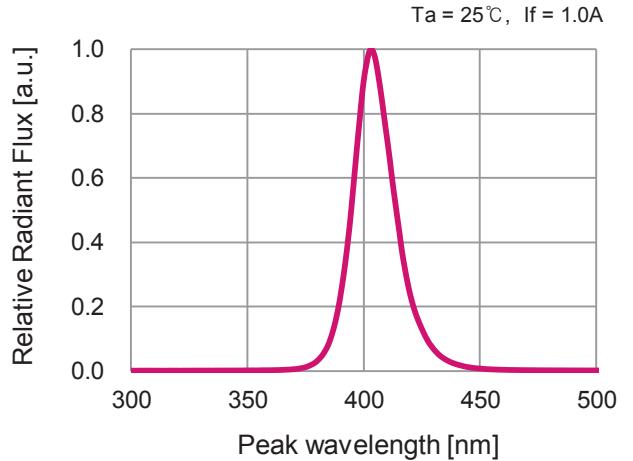

- Radiation Characteristics (Angle of Beam Spread, Directivity)

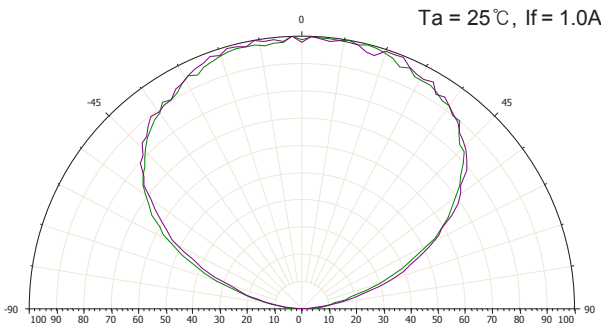

7. Typical Characteristic Curves

▪ Ambient Temperature vs. Relative Radiant Flux

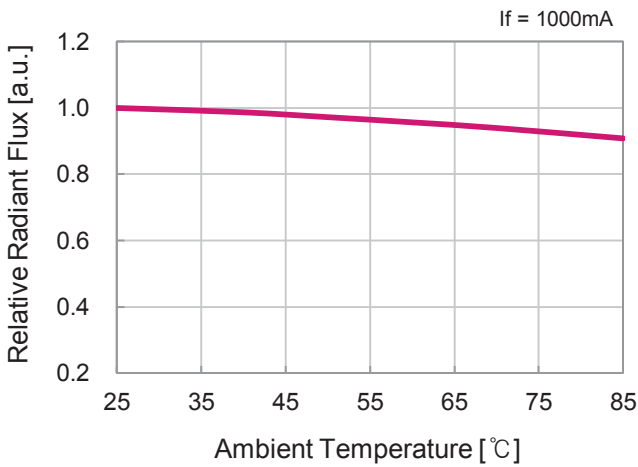

▪ Ambient Temperature vs. Peak Wavelength

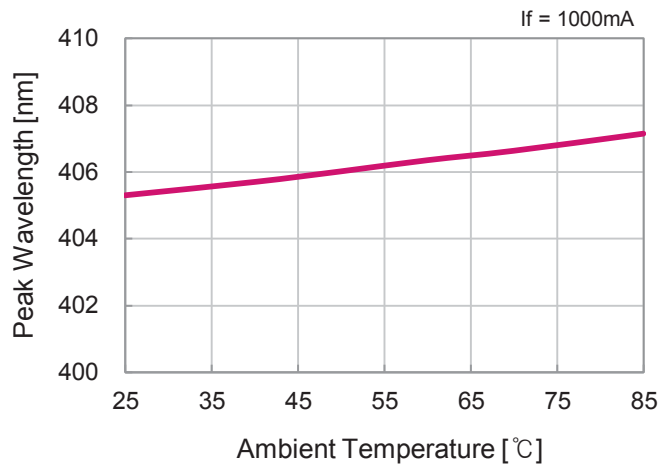

▪ Ambient Temperature vs. Forward Voltage

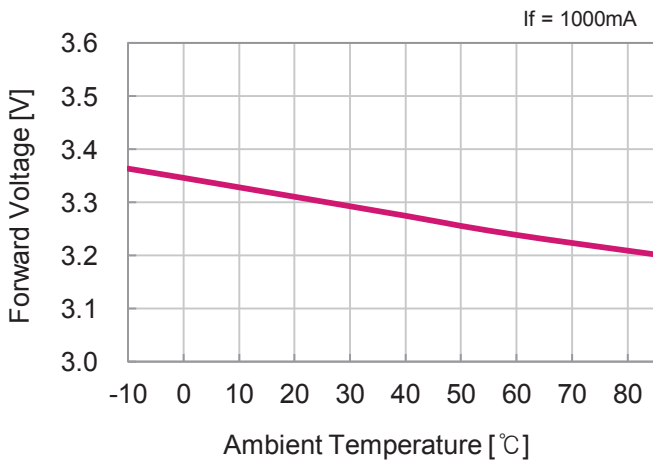

▪ Derating Curve

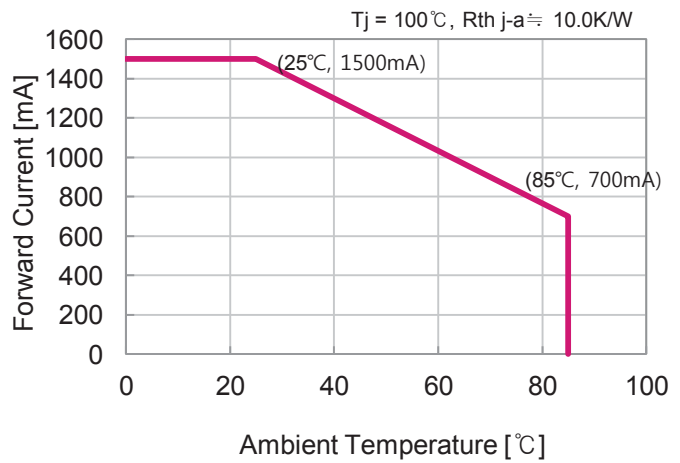

※ The ambient temperature values for each graph are obtained with LG Innotek equipment.

8. Reliability Test Items and Conditions

8-1. Failure Criteria

Items	Symbols	Test Conditions	Criteria	
			Min.	Max.
Forward Voltage	V _f	I _f = 1000mA	-	Initial Value × 1.1
Radiant Flux	Φ _e	I _f = 1000mA	Initial Value × 0.7	-

8-2. Reliability Tests

No	Items	Test Conditions	Test Hours /Cycles	Sample Size
1	Room Temperature Operating Life (RTOL)	T _a = 25 °C, I _f = 1500mA	1,000 Hours	10 pcs
2	High Temperature Operating Life (HTOL)	T _a = 85 °C, I _f = 700mA	1,000 Hours	10 pcs
3	Wet High Temperature Operating Life (WHTOL)	T _a = 60 °C, RH = 90%, I _f = 450mA	500 Hours	10 pcs
4	Low Temperature Operating Life (LTOL)	T _a = -10 °C, I _f = 1000mA	1,000 Hours	10 pcs
5	High Temperature Storage Life (HTSL)	T _a = 100 °C	1,000 Hours	10 pcs
6	Low Temperature Storage Life (LTSL)	T _a = -40 °C	1,000 Hours	10 pcs
7	Temperature Cycle (TC)	-40 °C (30min) ~ 100 °C (30min)	200 Cycles	10 pcs
8	Moisture Sensitivity Level (MSL)	T _{sld} = 260 °C (Pre treatment 60 °C, 60% 168 hours)	3 Times	10 pcs
9	Electrostatic Discharge	R = 1.5kΩ, C = 100pF, Test Voltage = 2kV, H.B.M.(Human Body Model)	3 Times Negative/ Positive	10 pcs
10	Vibration	100~2000~100Hz Sweep 4min. 200m/s ² , 3 directions	48 Minutes	10 pcs

※ All samples are tested using LG Innotek Standard Metal PCB (25x25x1.6 mm³(L×W×H)) except MSL test .

※ All samples must pass each test item and all test items must be satisfied.

9. Packing and Labeling of Products

9-1. Taping Outline Dimensions

Reel

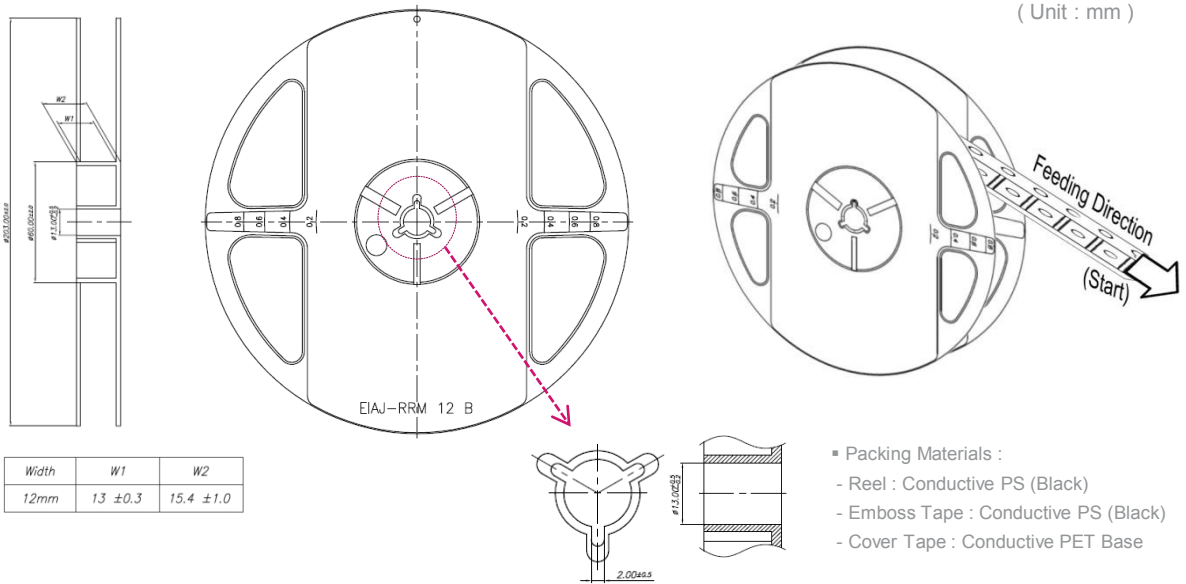

Tape

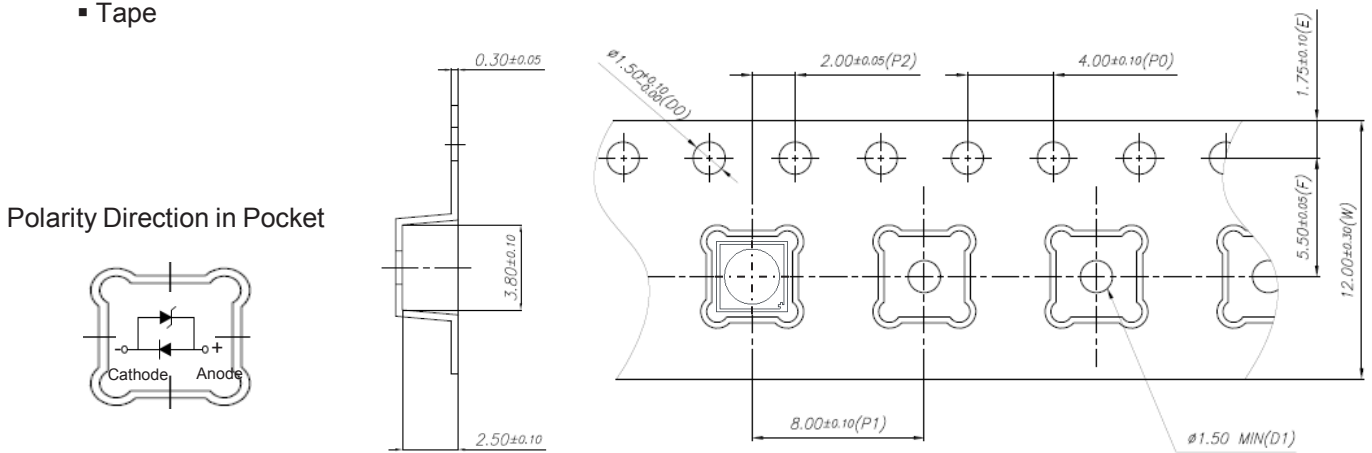

Taping Arrangement

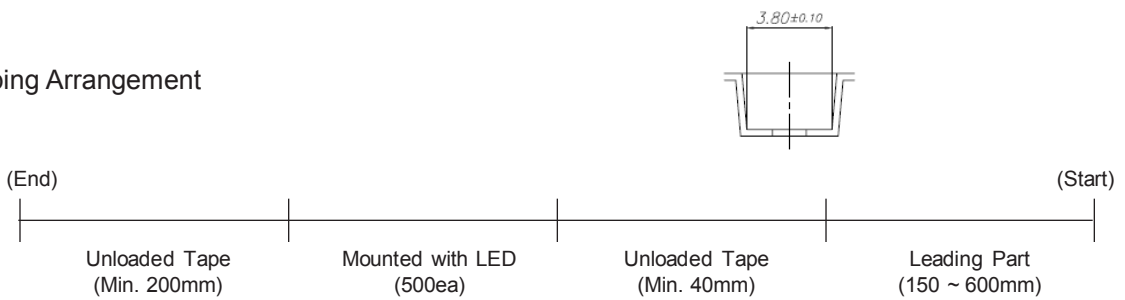

9. Packing and Labeling of Products

9-2. Package and Label Structure

※. Label A

Specifying 'Lot ID', 'Model Name', 'MES ID', 'RANK', 'Q'ty', 'Run No', 'Rack No.'

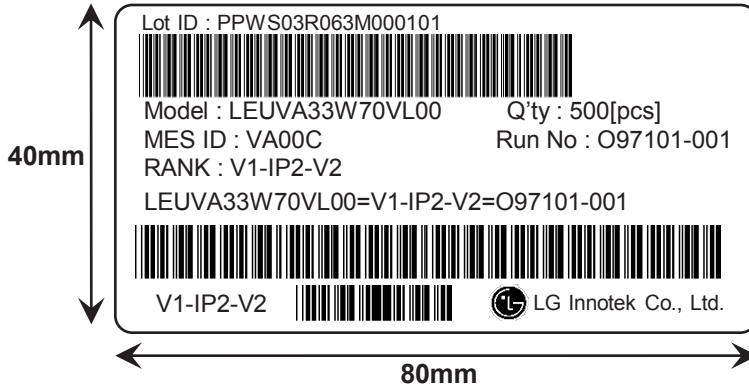

▪ Run No. Indication

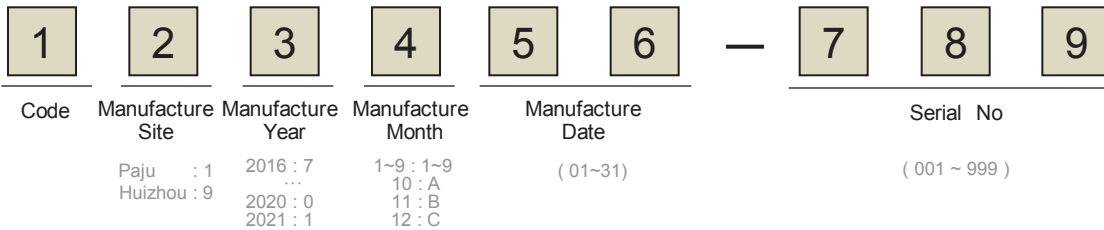

9. Packing and Labeling of Products

9-2. Package and Label Structure

※ Label C

Specifying Customer, Date, Model Name, Quantity, Customer Part Number, Outbox ID, Rank/Rank Quantity

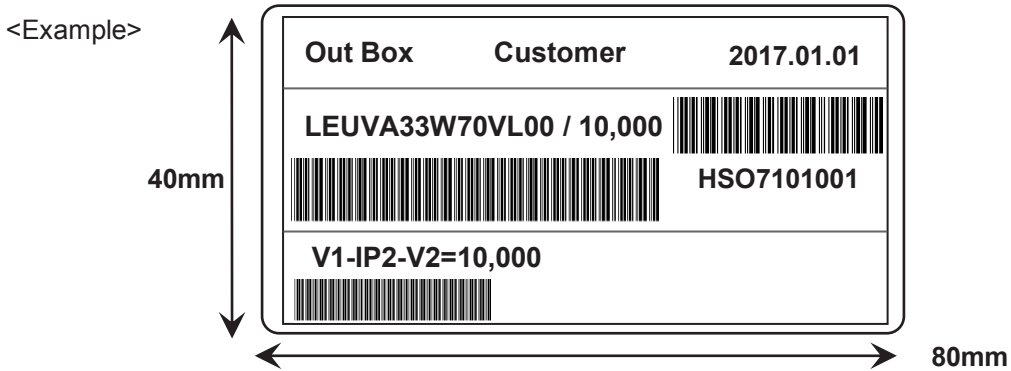

▪ Box ID. Indication

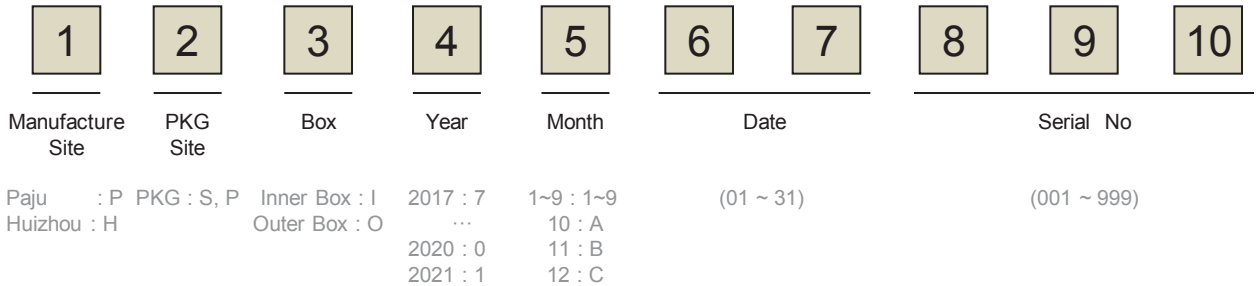

9. Packing and Labeling of Products

9-3. Packing Specifications

Reeled products (Numbers of products are Max. 500 pcs) packed in a sealed-off and moisture-proof aluminum bag with desiccants (Silica Gel). A Maximum four aluminum bags are packed in an inner box and six inner boxes are packed in an outer box. (Total Max. number of products are 12,000 pcs)

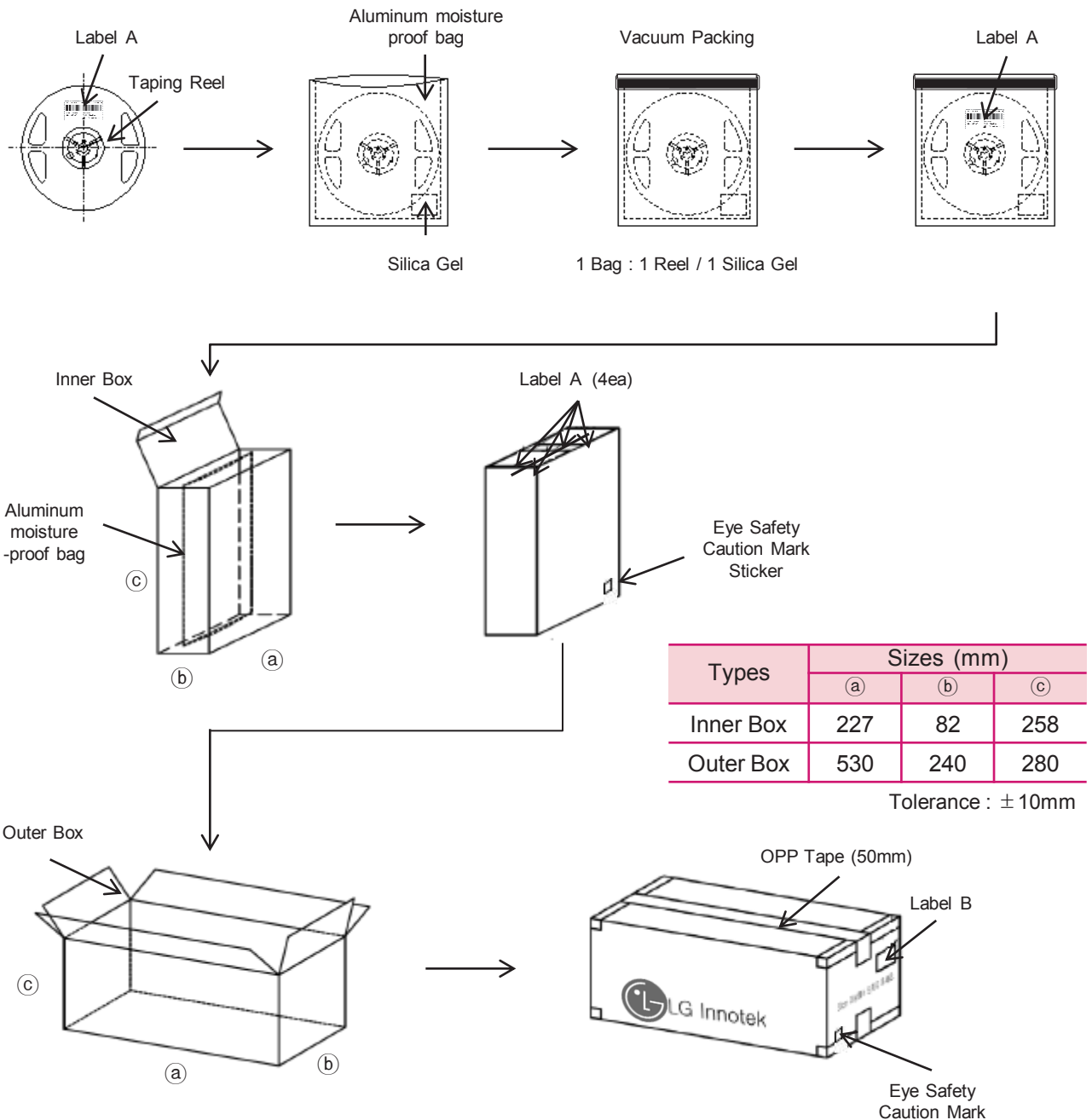

10. Cautions on Use

10-1. Moisture-Proof Package

- The moisture in the SMD package may vaporize and expand during soldering.
- The moisture can damage the optical characteristics of the LEDs due to the encapsulation.

10-2. During Storage

Conditions		Temperature	Humidity	Time
Storage	Before Opening Aluminum Bag	5°C ~ 30°C	< 50%RH	Within 1 Year from the Delivery Date
	After Opening Aluminum Bag	5°C ~ 30°C	< 60%RH	≤ 672 hours
Baking		65 ± 5°C	< 10%RH	10 ~ 24 hours

- The LEDs should be stored in a clean environment. If the LEDs are stored for 3 months of more after being shipped from LGIT, a sealed container with a nitrogen gas should be used for storage.
- When storing the LEDs after opening aluminum bag, reseal with a moisture absorbent material inside.

10-3. During Usage

- The LED should be avoided direct contact with hazardous materials such as sulfur, chlorine, phthalate, acid, solvent, etc. These materials(S, Cl, VOCs, etc) may cause sulfurization of silver lead-frame or encapsulant silicone discoloration in LED.
 VOCs(Volatile Organic Compounds) can be generated from adhesives glue, cleaning flux, molding hardener or organic additive which used in luminaires fixtures and they(VOCs) may cause a significant lumen degradation of LED in luminaires when they exposed to heat or light.
 To prevent this phenomenon, materials used in luminaires must be carefully selected by users.
- The metal parts(Including silver plated metal) on the LED can rust when exposed to corrosive gases. Therefore, exposure to corrosive gases must be avoided during operation and storage.
- The metal parts(Including silver plated metal) also can be affected not only by the corrosive gases emitted inside of the end-products but by the gases penetrated from outside environment.
- Extreme environments such as sudden ambient temperature changes or high humidity that can cause condensation must be avoided.

10-4. Cleaning

- Do not use brushes for cleaning or organic solvents (i.e. Acetone, TCE, etc..) for washing as they may damage the resin of the LEDs.
- Isopropyl Alcohol(IPA) is the recommended solvent for cleaning the LEDs under the following conditions.
 Cleaning Condition : IPA, 25°C max. × 60sec max.
- Ultrasonic cleaning is not recommended.
- Pretests should be conducted with the actual cleaning process to validate that the process will not

10. Cautions on Use

10-5. Thermal Management

- The thermal design of the end product must be seriously considered, particularly at the beginning of the system design process.
- The generation of heat is greatly impacted by the input power, the thermal resistance of the circuit boards and the density of the LED array combined with other components.

10-6. Static Electricity

- Wristbands and anti-electrostatic gloves are strongly recommended and all devices, equipment and machinery must be properly grounded when handling the LEDs, which are sensitive against static electricity and surge.
- Precautions are to be taken against surge voltage to the equipment that mounts the LEDs.
- Unusual characteristics such as significant increase of current leakage, decrease of turn-on voltage, or non-operation at a low current can occur when the LED is damaged.

10-7. Electrostatic Discharge (ESD)

- The LEDs are sensitive to static electricity or surge voltage and current.
The Electrostatic Discharge can damage a LED Chip.
Also, It can be affect a reliability belong to the life time of LED package.
When handling LEDs, the following measures against ESD are actively recommended :
 - 1) Please wear a wrist strap, anti-static clothes, foot wear and gloves.
 - 2) Please set up a grounded or anti-static paint floors, a grounded or the ability to surge protection -workstation equipment and tools.
 - 3) ESD protection- worktable/bench, mat made of a conductive materials.
- An appropriate grounding is required for all devices, equipment, and machinery used in product assembly.
Please apply surge protection after review when designing of commercial products(Curing Module, etc).
- If tools or equipment contain insulating materials such as glass or plastics, the following measures against ESD are strongly recommended :
 - 1) Dissipating static charge with conductive materials
 - 2) Preventing charge generation with moisture
 - 3) Plug in the ionizing blowers(ionizer) for neutralizing the charge
- The customer is advised to check if the LEDs are damaged by ESD when performing the characteristics inspection of the LEDs in the application.
Damage of LED can be detected with a forward voltage checking(measuring) at low current($\leq 1\text{mA}$).
- ESD damaged LEDs may have a current flow at a low voltage.
 - * Failure Criteria : $V_f < 2\text{V}$ at $I_f = 0.5\text{mA}$.

10. Cautions on Use

10-8. Recommended Circuit

- The current through each LED must not exceed the absolute maximum rating when designing the circuits.
- In general, there can be various forward voltages for LEDs. Different forward voltages in parallel via a single resistor can result in different forward currents to each LED, which also can output different luminous flux values. In the worst case, the currents can exceed the absolute maximum ratings which can stress the LEDs. Matrix circuit with a single resistor for each LED is recommended to avoid the luminous flux fluctuations.

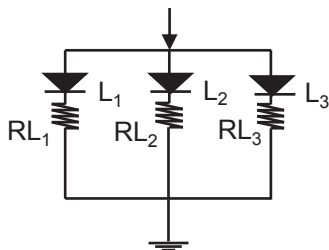

Fig.1. Recommended Circuit in Parallel Mode : Separate resistors must be used for each LED.

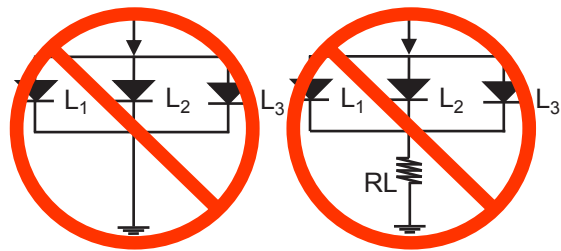

Fig.2. Abnormal Circuit : Avoid this circuits! The current through the LEDs may vary due to the variation in LED forward voltage.

- The driving circuits must be designed to operate the LEDs by forward bias only.
- Reverse voltages can damage the zener diode, which can cause the LED to fail.
- A constant current LED driver is recommended to power the LEDs.

10. Cautions on Use

10-9. Soldering Conditions

- Reflow soldering is the recommended method for assembling LEDs on a circuit board.
- LG Innotek does not guarantee the performance of the LEDs assembled by the dip soldering method.
- Recommended Soldering Profile (according to JEDEC J-STD-020D)

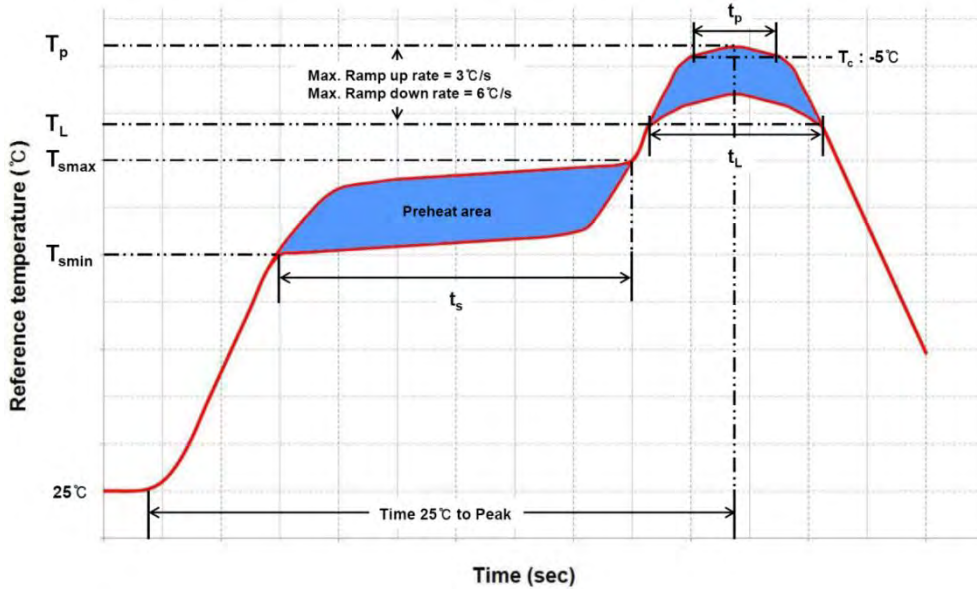

Profile Feature	Pb-Free Assembly	Pb-Based Assembly
Preheat / Soak		
Temperature Min (T_{smin})	150 °C	100 °C
Temperature Max (T_{smax})	200 °C	150 °C
Maximum time(t_s) from T_{smin} to T_{smax}	60~120 seconds	60~120 seconds
Ramp-up rate (T_L to T_p)	3°C / second max.	3°C / second max.
Liquidus temperature (T_L)	217 °C	183 °C
Time (t_L) maintained above T_L	60~150 seconds	60~150 seconds
Maximum peak package body temperature (T_p)	260 °C	235 °C
Time(t_p) within 5°C of the specified temperature (T_c)	30 seconds	20 seconds
Ramp-down rate (T_p to T_L)	6°C/second max.	6°C/second max.
Maximum Time 25°C to peak temperature	8 minutes max.	6 minutes max.

- Reflow or hand soldering at the lowest possible temperature is desirable for the LEDs although the recommended soldering conditions are specified in the above diagrams.
- A rapid cooling process is not recommended for the LEDs from the peak temperature.
- The silicone encapsulant at the top of the LED package is a soft surface, which can easily be damaged by pressure. Precautions should be taken to avoid strong pressure on the silicone resin when leveraging the pick and place machines.
- Reflow soldering should not be done more than two times.

10. Cautions on Use

10-10. Soldering Iron

- The recommended condition is less than 5 seconds at 260°C.
- The time must be shorter for higher temperatures. (+10°C → -1sec).
- The power dissipation of the soldering iron should be lower than 15W and the surface temperature of the device should be controlled at or under 230°C.

10-11. Eye Safety Guidelines

- Do not directly look at the light when the LEDs are on.
- Proceed with caution to avoid the risk of damage to the eyes when examining the LEDs with optical instruments.

10-12. Manual Handling

- Use Teflon-type tweezers to grab the base of the LED and do not apply mechanical pressure on the surface of the encapsulant.

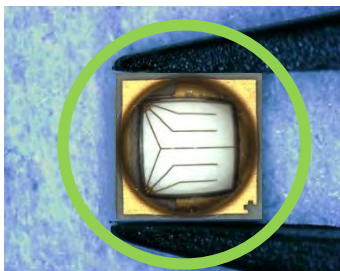

11. Disclaimers

- LG Innotek is not responsible for any damages or accidents caused if the operating or storage conditions exceed the absolute maximum ratings recommended in this document.
- The LEDs described in this document are intended to be operated by ordinary electronic equipment.
- It is recommended to consult with LG Innotek when the environment or the LED operation is non-standard in order to avoid any possible malfunctions or damage to product or risk of life or health.
- Disassembly of the LED products for the purpose of reverse engineering is prohibited without prior written consent from LG Innotek. All defected LEDs must be reported to LG Innotek and are not to be disassembled or analyzed.
- The product information can be modified and upgraded without prior notice.

